

PERFORMANCE THROUGH
PRECISION CONTROL

nimco
hydraulic systems



PRODUCT OVERVIEW

performance through precision control

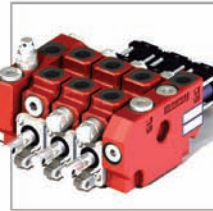
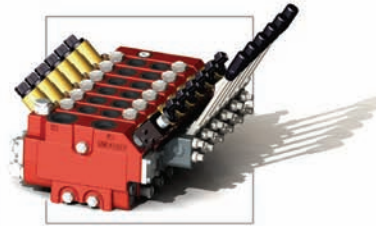

THE NIMCO COMMITMENT	PAGE 03
TECHNICAL DATA	PAGE 04
OPEN CENTER TECHNOLOGY	PAGE 06
LOAD SENSING TECHNOLOGY	PAGE 07
ELECTRO-HYDRAULIC PROPORTIONAL VALVES	PAGE 08
FLOW CONTROL VALVES	PAGE 11
OPEN CENTER VALVES	PAGE 12
PNEUMATIC AND CABLE CONTROLS	PAGE 14
CIRCUIT SELECTOR VALVES	PAGE 15
SPECIAL LOADER APPLICATION VALVES	PAGE 16
ACCESSORY VALVES	PAGE 18

THE NIMCO COMMITMENT	PAGE 03
TECHNICAL DATA	PAGE 04
OPEN CENTER TECHNOLOGY	PAGE 06
LOAD SENSING TECHNOLOGY	PAGE 07
ELECTRO-HYDRAULIC PROPORTIONAL VALVES	PAGE 08
FLOW CONTROL VALVES	PAGE 11
OPEN CENTER VALVES	PAGE 12
PNEUMATIC AND CABLE CONTROLS	PAGE 14
CIRCUIT SELECTOR VALVES	PAGE 15
SPECIAL LOADER APPLICATION VALVES	PAGE 16
ACCESSORY VALVES	PAGE 18

THE NIMCO COMMITMENT

Nimco has become a leading manufacturer and supplier of directional control valves, remote control units and system integration software in the mobile industry by our uncompromising commitment to quality, state of the art technology and our strong focus on our customers requirements combined with our prompt and responsive customer service level.

This commitment has been the foundation for our remarkable growth over the last twenty years and provides us with the incentive to actively take on the challenges our industry faces in the future.

For our customers, it means that whether it concerns new product development or the production of a single component, each and every step reflects our employees and our company's dedication to making every Nimco directional control valve, remote control unit or customized software design for system integration the very best available.

Our commitment to our customers starts with the development and testing that is put in to each and every product to guarantee stable and reliable performance throughout its entire application.

The close interaction with our customers during the entire development process assures that every aspect of each product application is accounted for and gives our research and development staff the feedback to develop the products of the future.

Over the years, this has enabled us to build a broad product range, reaching from traditional open center directional control valves to load sensing pressure compensated control valves which are further optimized by our PC based software integrated in our electrical proportional remote control units.

The foundation of production adapted designs with high performance machine tools and the testing of every product that is delivered assures that every machine equipped with a Nimco directional control valve and remote control unit delivers solid performance.

This is the Nimco Commitment to our customers today and in the future.

TECHNICAL DATA

ZERO LEAKAGE

Nimco Controls offers the markets lowest leakage rates for Directional Spool Control Valves. With special design concepts and manufacturing methods, which have been constantly improved are we able to offer our customers as low as 1 cc/min at 46 cSt leakage rates for certain products and an average of less than 2 cc/min leakage rates for larger valves.

The advantage of low leakage rates over the spool is that the load does not drift when the spool is in neutral position. Leakage rates as low as 1 cc/min allow customers to avoid using costly over center valves even for applications like support leg functions.

Nimco Controls is synonymous with low leakage directional control valves.

PRECISION LOAD CONTROL

One of the key performance factors in any machine is how well the load is controlled. The machine operators can perform more work in a safer way if they are operating a machine with a well designed Directional Control Valve.

A machines quality and reputation is often measured on how well the load is controlled at different stages of the load moving cycle and at different speeds. This requires the valve not only to control the load well when in a single step operation but how well the valve performs when multiple functions are activated at the same time. This holds true for both Open Center and Load Sensing valves.

Nimco Controls offers valves which can be tailored to each machines specific function and through our special spool design software, we can tailor every function to perform at the optimized speed and with a positive influence of all other functions.

Our Open Center valves are designed to take advantage of the full stroke of the valve and to have the same performance of each function even at largely different load weights.

Our Post Compensated Load Sensing valves will offer superior load control with its unique design where each spool has two compensators allowing customization of both the pressure and flow.

PRODUCTIVITY AND ENERGY SAVINGS

With energy prices continuing to climb and resources becoming more scarce Nimco Controls focuses on offering our customers components which will contribute to lower energy consumption.

Our target is to assist our customers and their customers to save money by consuming less fuel in their daily operation at the same or higher output levels.

Our target is to increase our customer's productivity.

Nimco Controls Open Center Valves are all designed to minimize pressure drop and to contribute to an overall efficient system performance. Valve designs are optimized to give excellent load control in combination with optimum energy usage.

Our LS Pressure Compensated Valves are designed to only make use of the flow and pressure required to work the machine in an optimal way and to do so in integration with our Electrical Control Units and EasyProg Software.

PRODUCTIVITY AND RELIABILITY

Nimco Controls has over the years earned the markets highest reputation for quality and reliability. For many machine builders are Nimco Controls components equal to the highest quality the market has to offer in terms of reliability, service life and maintenance.

Our philosophy of only designing with the best materials and a product that we ourselves would want to use have resulted in rough and tough products that will outlast most products available in the market today.

This makes servicing our customers easy and enjoyable!

PRODUCTIVITY AND CUSTOMIZATION

At Nimco we believe that the customer needs should be in the forefront of the work we do.

In today's demanding market a company has to be able to master all technologies available and to offer cost efficient solutions and thereby bring the next generation of machines to a higher level.

At Nimco Controls we combine our knowledge of hydraulic valve design, system and application knowledge and electro mechanics into one system and solution that will achieve the best performance for our customers.

OPEN CENTER TECHNOLOGY

Nimco offers open center valves with a flow rate up to 180 Lpm and 48 USGPM.

We offer all valves with standard spools which have high resolution metering as well as special tailored spools which are specifically designed to meet any machine specific load control needs.

In addition do we offer all our valves with spools that do not have any metering functions at all, but where spools are designed to allow for maximum flow through the valve at the lowest possible pressure drop.

Most of our open center valves can be equipped with secondary valve functions such as relief and anti-cavitation functions and also with electrical unloading valves in the valve inlets.

We offer a wide range of Spool Controls including Hand Levers, Cable, Pneumatic and Hydraulic Controls, as well as Electro Hydraulic on/off or Proportional Controls.

ON DEMAND LOAD SENSING

Most of Nimco's open center valves are designed so that they can be ordered in load sensing version which we call "On Demand Load Sensing". On demand load sensing valves enable the valve to work in a system where a variable displacement pump is the main source of oil and pressure supply.

The on demand load sensing valves will activate the pump when the spool is shifted from neutral position but does not offer individual pressure compensators for the spools.

Another interesting and useful feature on some of these valves is that it is possible to set the maximum flow of any section which cannot be exceeded during any time of operation.

OPEN CENTER DIRECTIONAL CONTROL VALVES WITH PRESSURE COMPENSATED FLOW CONTROL FUNCTION.

Nimco also offers directional control valve solutions where a spool control valve is combined with a pressure compensated flow control valve and the flow to a function is always prioritized and maintained independently of the operated load. These valves can be connected in series for multifunctional operation of for instance motors applications and in combination with a simple gear pump.

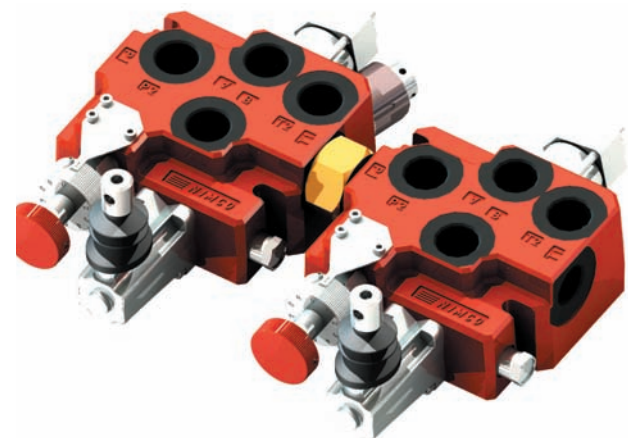

LOAD SENSING TECHNOLOGY

Nimco offers post compensated flow sharing load sensing valves which has the unique feature of having two compensators for each spool, thus better load control and welcome cost savings for the machine builder. For application where no flow sharing is needed are uncompensated sections available.

Inlet functions for fixed and variable displacement pumps with electrical off loading valves and HPCO (Power Beyond) functions are available as standard as well as special high flow inlets where a LS compensated spool eliminates the pressure drop between the pump and the valve.

Another unique feature with the Nimco LS valves is that by having two compensators for each spool, it is possible to equip the valves with LS pressure relief valves for each cylinder port and thereby limit the internal pump pressure to be exceeded without consuming any pump flow.

Other standard equipments for the Nimco LS valves are: Manual override hand levers with integrated stroke limiters and secondary relief valves with integrated anti cavitation functions.

Spool controls options range from manual controls to hydraulic and EHP controls.

SYSTEM INTEGRATION SOLUTIONS

In order to use these products to its fullest potential does Nimco offer a system integration software named EasyProg which offers a user friendly PC environment and allows the machine builder to program, revise and maintain all components integrated in the system.

Nimco offers a complete range of control units, driver boxes and sensors to make system programming and machine installation fast and easy with the highest accuracy.

Servicing any machine with a Nimco system is easy as remote control GSM units are available as standard to monitor, diagnose and reprogram machines in the field.

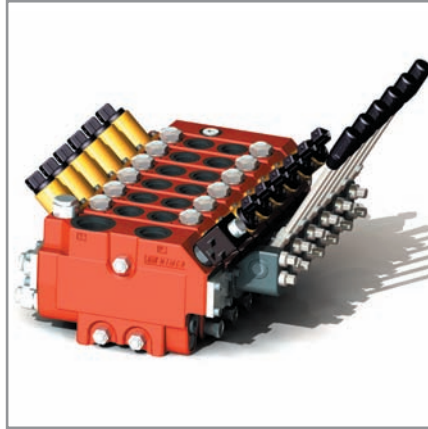

CV2000LS

**Design**

Stackable
up to 10 sections

Flow Range

up to 125 Lpm
up to 33 USGpm

Max Pressure

320 bar
4600 psi

Port Sizes

BSP 1/2"
SAE 10

Circuits

LS Post Compensated
Fixed and Variable Pump

Controls

EHP
Hydraulic
Hand Lever

Accessories

Port Pressure Limiters
Electrical OFF loading valve
Antichock Valves
Anticavitation Valves
HPCO - Power Beyond
Spool Stroke Limiters

CV3000

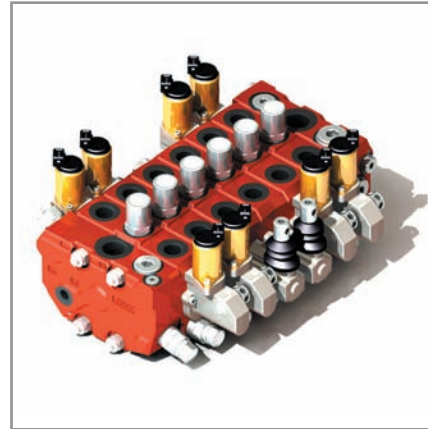
**Design**

Stackable
up to 10 sections

Flow Range*

up to 100 Lpm
up to 26 USGpm

Max Pressure

320 bar
4600 psi

Port Sizes

BSP 3/8" - BSP 1/2"
SAE 8 - SAE 10 - SAE 12

Circuits

Open Center
Closed Center

Controls

EHP
Hydraulic
Pneumatic
Cables
Hand Lever

Accessories

HPCO - Power Beyond
Antichock Valves
Anticavitation Valves
Electrical OFF Loading Valve

*possibility of setting a fixed
flow on each valve section

CV550EHP

**Design**

Stackable
up to 10 sections

Flow Range

up to 90 Lpm
up to 24 USGpm

Max Pressure

350 bar
5000 psi

Port Sizes

BSP 1/2"
SAE 8 - SAE 10

Circuits

Open Center
LS on Demand

Controls

EHP
Cables
Hand Lever
Pneumatic
Mechanical Joystick

Accessories

Antichock Valves
Anticavitation Valves
HPCO - Power Beyond

EPC100

**Design**

Joystick 1-Axis

Power Supply / Output Signal

10-30 VDC / 4-20 mA
4,5-5,5 VDC / 0,5-5,5 VDC
10-30 VDC / 0,5-4,5 VDC

EPC 300

**Design**

Joystick 2-Axis

Power Supply / Output Signal

10-30 VDC / 4-20 mA
4,5-5,5 VDC / 0,5-5,5 VDC
10-30 VDC / 0,5-4,5 VDC

Options

1 or 3 El. Push Buttons

EPC 350

**Design**

Joystick 3-Axis

Power Supply / Output Signal

4,5-5,5 VDC / 0,5-5,5 VDC

**Design**

Joystick 2-Axis

Power Supply / Output Signal

10-30 VDC / 4-20 mA
4,5-5,5 VDC / 0,5-5,5 VDC
10-30 VDC / 0,5-4,5 VDC

Handgrip

Max 3 Potentiometers and Max
6 Push Buttons
Left and right hand version

**Design**

Driver Box 4+4 PWM output

Power Supply / Output Signal

10-30 VDC / 4-20 mA
4,5-5,5 VDC / 0,5-5,5 mA
10-30 VDC / 0,5-4,5 mA

Can Protocol

2.0 B

Current Feedback

100-1800 mA

Chopper Frequency

30/200 Hz

**Design**

Programming software to control
our Electro-Hydraulic Systems.

Languages

English
German
Swedish

PC Compatible**Design**

Pressure Compensated Flow
Control Valve
Stackable up to 3 Valves

Flow Range

110 or 130 Lpm
29 or 34 USGpm

Max Pressure

320 bar
4600 psi

Port Sizes

BSP 3/4"
SAE 12

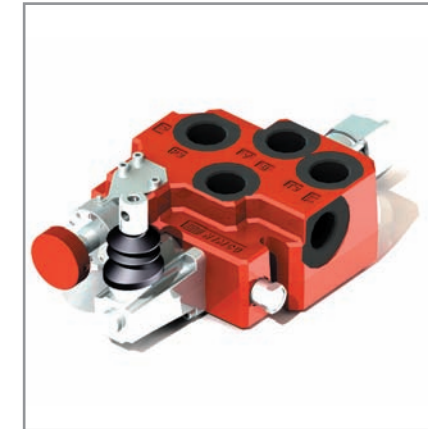
**Design**

Directional Control Valve with
integrated Pressure Compensated
Flow Control Valve
Monoblock
1 section for single Motor Control

Flow Range

110 or 130 Lpm
29 or 34 USGpm

Max Pressure

320 bar
4600 psi

Port Sizes

BSP 3/4"
SAE 12

Circuits

Open Center

Controls

Handlever

Accessories

HPCO - Power Beyond
Pressure Cut OFF valve

**Design**

Directional Control Valve with
integrated Priority Flow Control Valve
Monoblock
1 section with HPCO option for 2 Motor
Controls

Flow Range

110 or 130 Lpm
29 or 34 USGpm

Max Pressure

320 bar
4600 psi

Port Sizes

BSP 3/4"
SAE 12

Circuits

Open Center

Controls

Handlever

Accessories

HPCO - Power Beyond
Extra Main Relief Valve
Pressure Cut OFF valve

CV110

**Design**

Monoblock
From 1 to 6 sections

Flow Range

up to 50 Lpm
up to 13 USGpm

Max Pressure

320 bar
4600 psi

Port Sizes

BSP 3/8"
SAE 6

Circuits

Open Center
LS on Demand

Controls

EHP
Pneumatic
Hydraulic
Cable
Hand Lever
Mechanical Joystick

Accessories

HPCO - Power Beyond
Zero Leak Spools

CV126

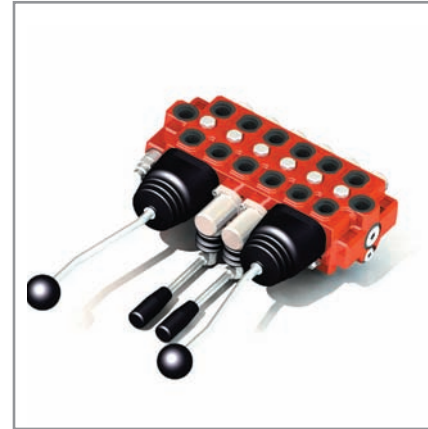
**Design**

Monoblock
6 sections Special Backhoe Valve

Flow Range

up to 50 Lpm
up to 13 USGpm

Max Pressure

320 bar
4600 psi

Port Sizes

BSP 3/8"
SAE 6

Circuits

Open Center
LS on Demand

Controls

EHP
Pneumatic
Hydraulic
Cable
Hand Lever
Mechanical Joystick

Accessories

Antichock Valves
Anticavitation Valves
HPCO - Power Beyond
Zero Leak Spools

CV400

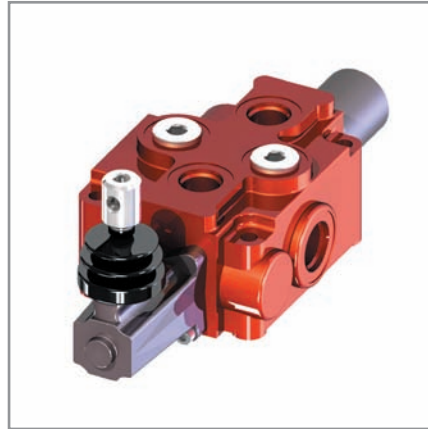
**Design**

Monoblock
From 1 to 4 sections

Flow Range

up to 80 Lpm
up to 21 USGpm

Max Pressure

320 bar
4600 psi

Port Sizes

BSP 1/2"
SAE 8 - SAE 10

Circuits

Open Center

Controls

EHP
Pneumatic
Hydraulic
Cable
Hand Lever
Mechanical Joystick

Accessories

Antichock Valves
Anticavitation Valves
HPCO - Power Beyond

CV300

**Design**

Monoblock
From 1 to 6 sections

Flow Range

up to 140 Lpm
up to 37 USGpm

Max Pressure

320 bar
4600 psi

Port Sizes

BSP 3/4"
SAE 12

Circuits

Open Center

Controls

EHP
Pneumatic
Hydraulic
Cable
Hand Lever
Mechanical Joystick

Accessory Valves

Antichock valves
Anticavitation valves
HPCO - Power Beyond

CV601

**Design**

Monoblock
1 section

Flow Range

up to 180 LPM
up to 47 USGpm

Max Pressure

320 bar
4600 psi

Port Sizes

BSP 3/4" on Ports, 1" on T1
SAE 12 on Ports, SAE 16 on T1

Circuits

Open Center

Controls

EHP
Pneumatic
Hydraulic
Cable
Hand Lever
Mechanical Joystick

Accessories

HPCO - Power Beyond

CV550

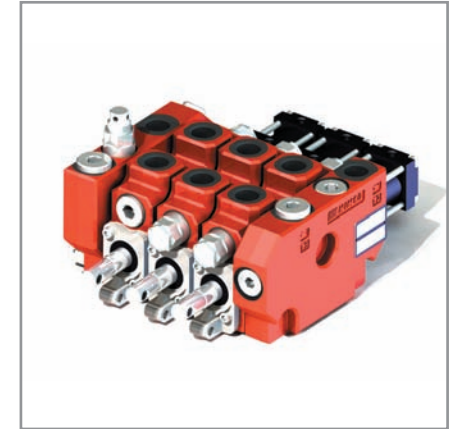
**Design**

Stackable
Up to 10 sections with Mid Inlet Sections

Flow Range

up to 90 Lpm
up to 24 USGpm

Max Pressure

350 bar
5000 psi

Port Sizes

BSP 1/2"
SAE 8

Circuits

Open Center
LS On Demand

Controls

EHP
Pneumatic
Hydraulic
Cable
Hand Lever
Pneumatic
Mechanical Joystick

Accessories

Antichock Valves
Anticavitation Valves
HPCO - Power Beyond
Sections with Load Holding Valves

WK300

**Design**

Mechanical Joystick for cables
2-Axis or 1-Axis
Mechanical Lock

Max Operating Current of buttons

6A

Options

Individual Logo

Number of Switch available

0-, 1-, 2-, 3- El. Push Buttons

PPC

**Design**

Manual Pneumatic Control Unit
Bankable

Max Pressure

10 bar
145 psi

Control Pressure

0-7 bar
0-100 psi

Options

Spring Centering
Detent in middle position
Detent in middle and one end position
Detent in all 3 positions
Detent in both end positions
2 position electrical switch
3 position electrical switch

PNEUMATIC BOX

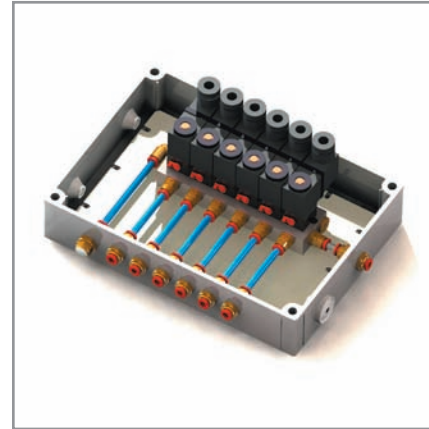
**Design**

Electrical Pneumatic Box

No of Solenoid Valves

6, 8 or 10 valves inside each box

Operating Voltage

12 or 24 VDC

Max Pressure

10 bar
145 psi

Options

Heater
IP67

SVL

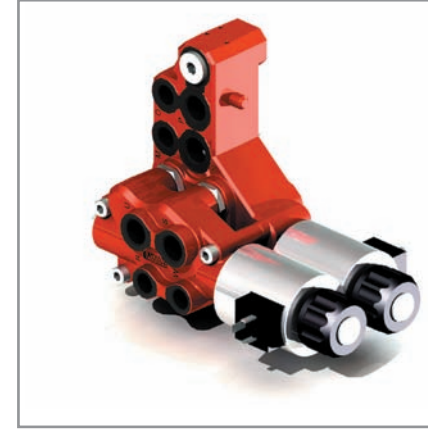
**Design**

Stackable 6/2 and 8/2 valve

Flow Range

up to 90 Lpm
up to 24 USGpm

Max Pressure

280 bar
4100 psi

Port Sizes

BSP 3/8" - BSP 1/2"
SAE 6 SAE 8

Controls

Direct Acting Solenoid
Hand Lever

Accessories

Cross-Over Relief Valves
Manual or Electrical Activation of the Accumulator
Electrical Tool Locking Valve

Electrical Activation

12 VDC or 24 VDC

Connector Options

DIN 43650/ISO4400

RRV

**Design**

Single Spool

Flow Range

up to 150 Lpm
up to 40 USGpm

Max Pressure

270 bar
3900 psi

Port Sizes

BSP 1/2"
SAE 8

Controls

Hand Lever
Pneumatic ON/OFF
Pneumatic with 12 or 24 VDC
Cam operated
Tilt Lever

SVB

**Design**

6/2 Circuit Selector Valve
Stackable up to 3 valve sections

Flow Range

up to 90 Lpm
up to 24 USGpm

Max Pressure

280 bar
4100 psi

Port Sizes

BSP 3/8" - BSP 1/2"
SAE 8 SAE 10

Controls

Direct Acting Solenoid
Hand Lever
Pneumatic

Electrical Activation

12 or 24 VDC

Connector Options

DIN 43650/ISO4400

CV112

**Design**

Monoblock
2 sections

Flow Range

up to 50 Lpm
up to 13 USGpm

Max Pressure

320 bar
4600 psi

Port Sizes

BSP 3/8"
SAE 6

Circuits

Open Center
LS on Demand

Controls

EHP
Cables
Hand Lever
Mechanical Joystick

Accessories

HPCO - Power Beyond

CV152

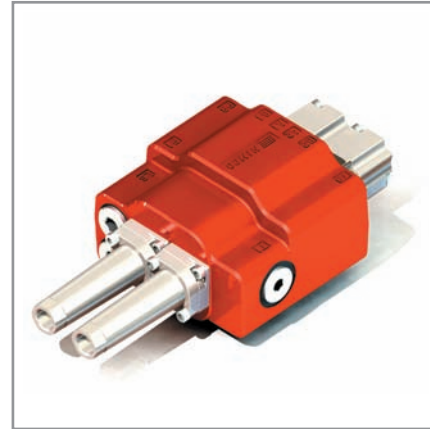
**Design**

Monoblock
2 sections

Flow Range

up to 70 Lpm
up to 18 USGpm

Max Pressure

320 bar
4600 psi

Port Sizes

BSP 3/8" - BSP 1/2"
SAE 8 - SAE 10

Circuits

Open Center
LS on Demand

Controls

Direct Acting Joystick with
Locking Mechanism
Cables
Hand Lever

Accessories

HPCO - Power Beyond
Quick Coupler Unit

CV432 & CV432S

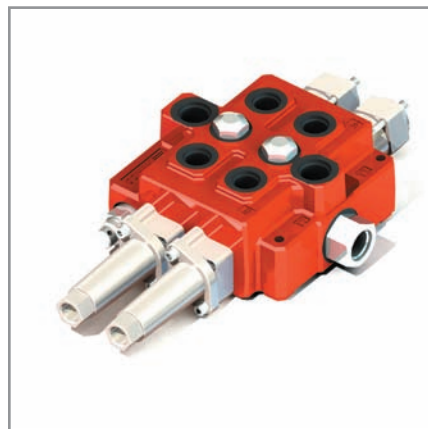
**Design**

Monoblock
2 sections

Flow Range

up to 100 Lpm for O/C version
up to 26 USGpm for O/C version

up to 70 Lpm for Series Version
up to 18 USGpm for Series Version

Max Pressure

320 bar
4600 psi

Port Sizes

BSP 1/2" - BSP 3/4"
SAE 8 - SAE 10

Circuits

Open Center
Series Circuit

Controls

Direct Acting Joystick with Locking
Mechanism
Cables
Hand Lever

Accessories

HPCO - Power Beyond
Quick Coupler Unit

CV452

**Design**

Monoblock
2 sections

Flow Range

up to 110 Lpm
up to 29 USGpm

Max Pressure

320 bar
4600 psi

Port Sizes

BSP 1/2"
SAE 8 - SAE 10

Circuits

Open Center
LS on Demand

Controls

Manual
Cable
Hand Lever
Mechanical Joystick

Accessories

HPCO - Power Beyond
Antichock Valves
Anticavitation Valves
Quick Coupler Unit

CV652

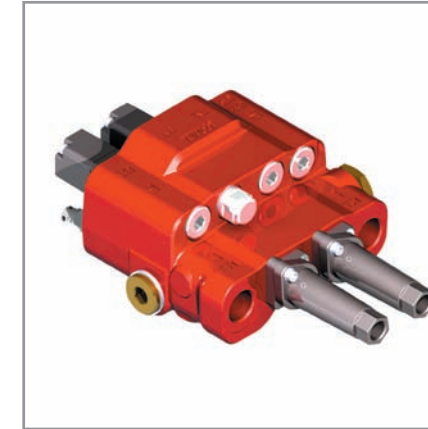
**Design**

Monoblock
2 sections

Flow Range

up to 120 Lpm
up to 32 USGpm

Max Pressure

320 bar
4600 psi

Port Sizes

BSP 1/2"
SAE 8 - SAE 10

Circuits

Open Center
LS on Demand

Controls

Direct Acting Joystick with
Locking Mechanism
Cables
Hand Lever

Accessories

HPCO - Power Beyond
Antichock Valves
Anticavitation Valves
Quick Coupler Unit

EPCV652

ELECTRO HYDRAULIC

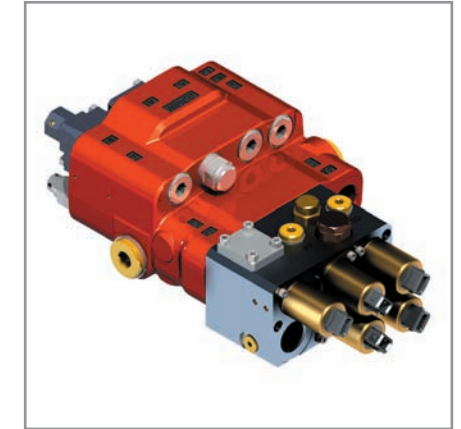
**Design**

Monoblock
2 sections

Flow Range

up to 120 Lpm
up to 32 USGpm

Max Pressure

320 bar
4600 psi

Port Sizes

BSP 1/2"
SAE 8 - SAE 10

Circuits

Open Center
LS on Demand

Controls

EHP

Accessories

HPCO - Power Beyond
Antichock Valves
Anticavitation Valves
Quick Coupler

**Design**

Relief Valve Cartridges in Aluminium or Steel blocks

Flow Range

Up to 150 Lpm
Up to 40 USGpm

Max Pressure

400 bar
5800 psi

Port Size

BSP 1/2" - BSP 3/4" - BSP 1"

Circuits

End - Line
In - Line
Cross-Over

Options

Fixed or Adjustable Pressure Settings

**Design**

Relief, Relief-Anticavitation and Pressure Reducing Valves of Cartridge type

Flow Range

Up to 150 Lpm
Up to 40 USGpm

Max Pressure

400 bar
5800 psi

Design Type

Direct Acting
Pilot Acting

Options

Fixed or Adjustable Pressure Settings

HFI Fluid Power

Racine, WI 53403
262-634-5534
Illinois
Wisconsin

Hydrotech

Cincinnati, OH 45246
513-881-7000
Michigan
Ohio

IFP - Kansas (West)

Olathe, KS 66062
913-768-7008
Arizona
California
Iowa
Kansas
Missouri
New Mexico

IFP - Cedar Rapids (Iowa Fluid Power)

Iowa -319-395-7000

IFP - Minnesota - North

Coon Rapids, MN
763-252-1181
Minnesota
Nebraska
North Dakota
South Dakota

USA**HFI Fluid Power**

1210 Washington Ave
Racine, WI 53403
262-634-5584

Hydrotech

10052 Commerce Park Drive
Cincinnati, OH 45246
513-881-7000

IFP - Cedar Rapids

1610 Blairs Ferry Rd. N
Cedar Rapids, IA 52402
319-395-7000

IFP - North

9320 Evergreen Blvd
Suite A
Minneapolis, MN 55433
763-252-1181

IFP - Texas

2517 Fairway Park Drive
Houston, TX 77092
800-437-4595

IFP - Texas

Houston, TX 77092
713-360-3600
Arkansas
Colorado
Louisiana
Mississippi
Nevada
Oklahoma
Texas
Utah

IFP Automation

Fort Wayne, IN 46898
260-489-4575
Indiana

Integrated Automation

Easley, SC 29640
864-220-9898
Alabama
Florida
Georgia
Kentucky
North Carolina
South Carolina
Tennessee
Virginia
West Virginia

IFP - West

1900-A West 158th St.
Olathe, KS 66062
913-768-7008

IFP Automation

3911 Merchant Rd
Fort Wayne, IN 46898
260-489-4575

Integrated Automation

132 Kay Drive
Easley, SC 29640
800-732-8704

LaDuke & Fogle Equipment

635 Hwy. 395 South
Colville, WA 99114
509-684-2575

Livingston & Haven

11616 Wilmar Blvd
Charlotte, NC 28273
704-588-3670

LaDuke & Fogle Equipment

Colville, WA 99114
509-684-2575
Idaho
Montana
Oregon
Washington
Wyoming

Standard Source

Webster, MA 01570
508-949-0308
Connecticut
Delaware
Maine
Maryland
Massachusetts
New Hampshire
New Jersey
New York
Pennsylvania
Rhode Island
Vermont

Drive Products

Mississauga, ON
905-564-5800
Canada

Oil-Air Products

295 Hwy 55
Hamel, MN 55340
763-478-8744

PRC

337 Perry Road
Bangor, ME 04401
800-840-4411

Standard Source

1 Cody Street
Webster, MA 01570
508-949-0308

CANADA**Drive Products**

1665 Shawson Drive
Mississauga, ON L4W 1T7
905-564-5800

